

# Bracket Sign System



## Features and Benefits

- ◆ Create your own sign system using siffron's interchangeable sign holders and brackets
- ◆ Sign Holders are available in flag and flush styles, in multiple sizes and colors
- ◆ Select SuperGrip® styles for the most secure hold on signage
- ◆ Our wide variety of brackets are compatible with gondola shelf channels, gondola and warehouse uprights, pegboard, slatwall, square-edge fixtures, and flat surfaces

## An easy to use sign system

1. Choose any Sign Holder/Adapter
2. Select any Bracket
3. Insert the Sign Holder onto the Bracket

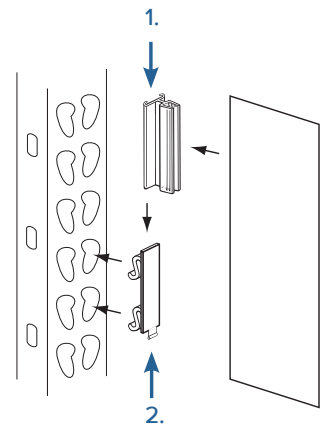
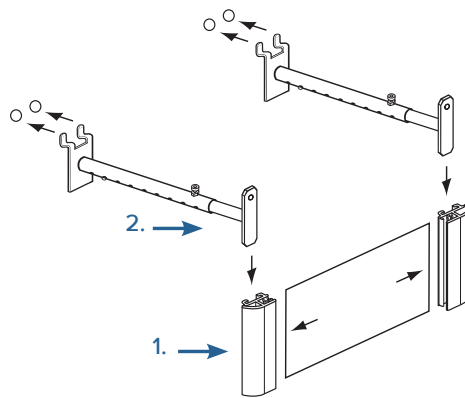

See back of sheet for components. →

20190319

For more information,  
call **800.422.2547**  
or visit **www.siffron.com**

**siffron**<sup>™</sup>  
always on

# Bracket Sign System

## Bracket Sign System – Sign Holders

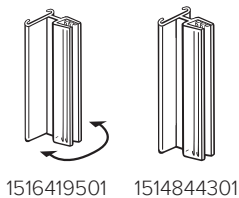

SuperGrip® Sign Holder

1516419501

1514844301

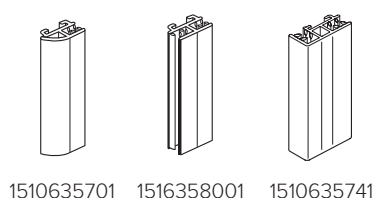

SuperGrip® Header Sign Holder

1510635701

1516358001

1510635741

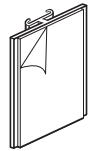

1503322301

Flush Mount Adapter for Bracket System

## Bracket Sign System – Brackets

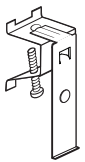

Metal Channel Mount Bracket

PATENTED

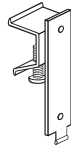

Channel Mount Bracket

PATENTED

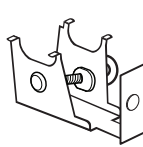

Under-Shelf Spring-Mount Bracket

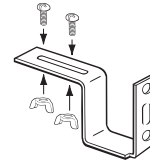

Under-Shelf Mount Bracket

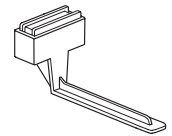

Magnetic Under-Shelf Mount Bracket, L-Style

PATENTED

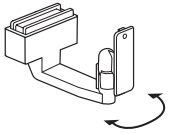

Magnetic Under-Shelf Mount Bracket w/ Swivel

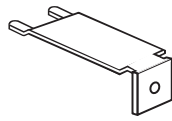

Metal Shelf-Top Bracket

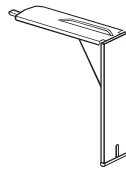

Shelf-Top Bracket

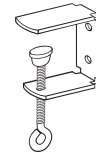

Metal C-Clamp Bracket

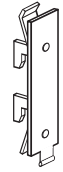

Gondola Upright Bracket



Upright Mount Plate for SuperGrip®



Pegboard Bracket



Pegboard / Slatwall Mount Plate for SuperGrip®



Slatwall Bracket



Warehouse Upright Bracket, Teardrop Hole



Warehouse Upright Bracket, Square Hole

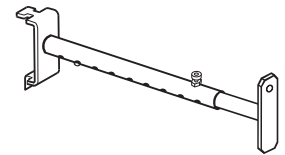

Metal Telescopic Bracket

20190319

For more information,  
call **800.422.2547**  
or visit [www.siffron.com](http://www.siffron.com)

**siffron**™  
always on